

Series P-HF

High Flow Vertical Pump



Model P-7 1/2-HF

Features:

- CPVC Construction
- No Metal Contact
- Chemical Resistant
- Self-Priming When Immersed
- Run Dry Capability Without Damage
- Flows to 400 GPM
- Pressure to 145 Ft. TDH

Recommended Applications:

- Sump Pumping
- Transfer Pumping
- Recirculation Pumping
- Plating Solution Filtering
- Fume Scrubbing
- Waste Treatment
- Eductor Systems
(see back page)

Our Penguin Series P-HF CPVC vertical pumps are simple in design, efficient in performance, and self-priming when immersed in solution. With a double impeller design and no seals to leak or bushings or bearings to wear, this pump can run dry without damage while requiring little or no maintenance. Constructed completely of CPVC where in contact with the solution, this pump is suitable for pumping, agitating, filtering, or recirculating acid or alkaline corrosive solutions over the entire 0-14 pH range up to 180°F maximum temperature.

Standard motors are three phase and totally enclosed fan cooled, with two part epoxy coating for additional corrosion resistance. A rigid, solid stainless steel rotor/drive shaft with an oversized bearing is employed to minimize shaft alignment problems, while allowing for quick and easy bearing replacement when required. The three phase motors are shipped unwired. A standard air purge/vent screw assembly in the bottom motor housing extends the life of the bottom motor bearing when utilizing minimal 5 psi air to create a positive displacement.

Top View

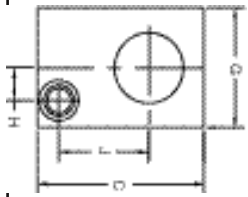

P-7 1/2, 10 & 15

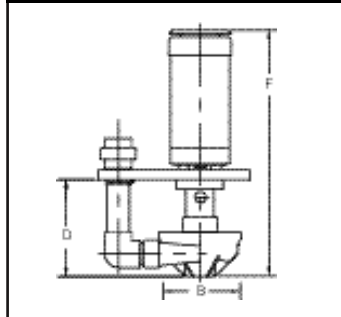

High Flow Vertical Pump



Extended Model
Also, available
See Bulletin # 216

Dimensions

Model	B	C	Suction	Discharge	D	F	G	H	J
P-7 1/2-HF	13 1/8	23 3/4	3" FPT	3" FPT	15 5/8	38	16 7/8	4 5/8	13 1/8
P-10-HF						39 1/2			
P-15-HF									

Specifications

Model	Max Flow (gpm)	Max Head (ft)	Max Flow 50Hz	Max Head 50Hz	Motor						Dimensions			
					HP	RPM	Volts	Hertz	Phase	Amps	Ht	Wth	Lth	Wt
P-7 1/2-HF	300	105	300	95	7 1/2	3450	208-230/460	50/60	3	19-18/9	25	36	48	300
P-10-HF	350	122	350	113	10					27-25/12.5				310
P-15-HF	419	157	N/A	N/A	15					38-35/17.5				320

Nomenclature

P	-	10	AK	C	-	HF
Penguin Vertical Pump		Horsepower 7 1/2=7 1/2 10=10 15=15	Construction Material/ O-Ring Elastomer Material A=CPVC/EPR	Impeller Material Construction None=Standard		Housing Construction HF=High Flow

Series P-HF

Performance Curves

P-7 1/2AK-HF

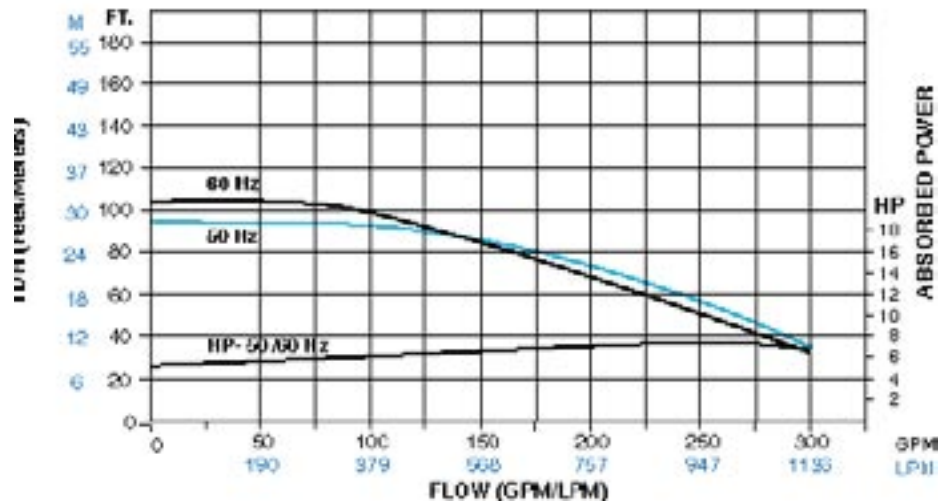

P-10AK-HF

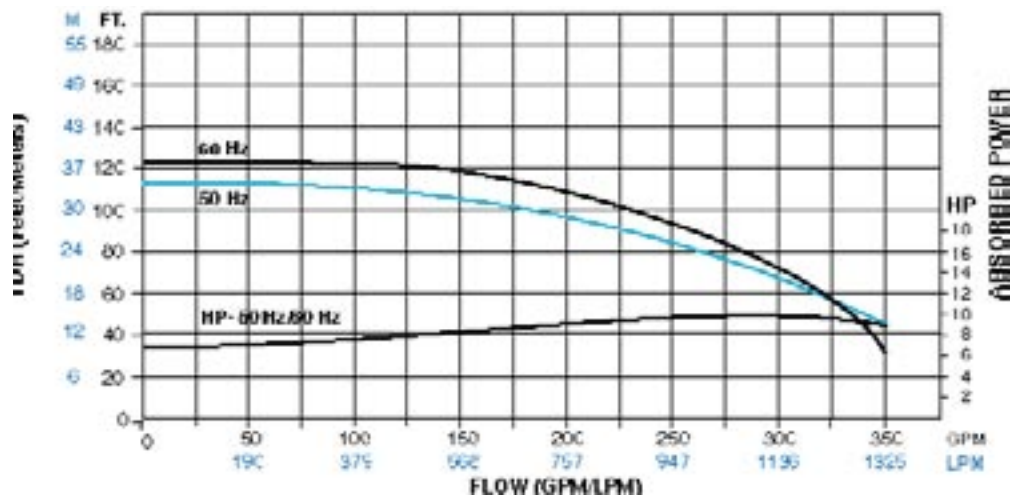

P-15AK-HF

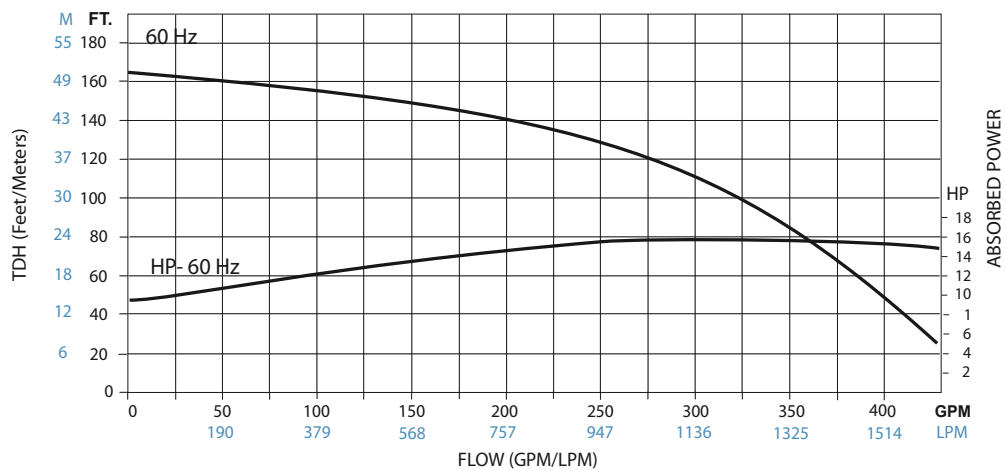

PENGUIN

Penductor Systems

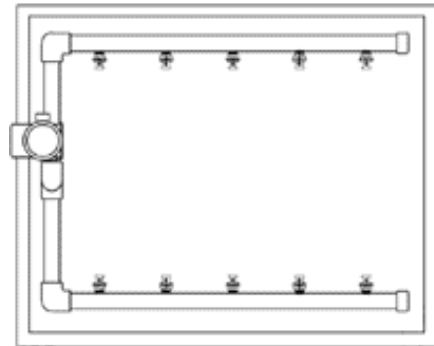
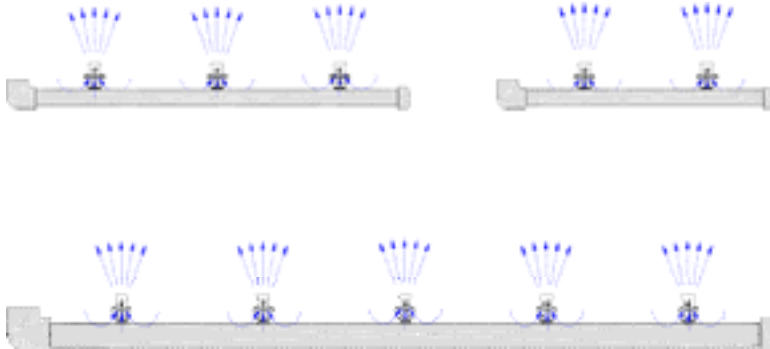
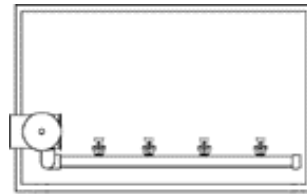

Features:

- Available as systems with pumps, kits, or Penductors™ sold separately
- Deluxe model includes adjustable nozzles
- Non-metallic contact with solution
- Perfect for large tank usage
- Induces four extra gallons of flow for every gallon pumped through nozzle
- Used to enhance circulation in a wide variety of recirculating process tanks.

Ideal for:

- Vigorous and constant agitation
- Dispersing and mixing chemicals more uniformly
- Eliminating hot spots/temperature stratification
- “Sweeping” debris or sludge toward a filter intake
- Keeping solids in suspension
- Mixing immiscible liquids
- Allowing for increased density causing faster plating rates
- Eliminating aeration and gas pitting problems

- Creating more uniform plating distribution
- Permitting considerable improvements in plating throw and deposit in blind holes and recesses

Recommended Applications:

- Eductors are currently installed in the following types of re-circulating process tanks:

- Cleaners
- E-coat paints and paint strippers
- Chemicals, fertilizers, caustics, and permanganates
- PCB plating sludge
- Cooling towers
- Slurries
- Plating tanks:
 - Chromium
 - Anodizing
 - Phosphate
 - Bright Nickel
 - Electroless Nickel/Copper
 - Etching
 - Phosphate
 - Acid Copper
 - Tin
 - Acid Zinc
 - Gold
 - Silver
 - Alloys